

TOPCOM[®]

BUTLER 4012 USB VOIP



USER GUIDE

2.1



Important

To use 'Caller ID' (display caller), this service has to be activated on your phone line. Normally you need a separate subscription from your telephone company to activate this function. If you don't have the Caller ID function on your phone line, the incoming telephone numbers will NOT be shown on the display of your telephone.

This product is in compliance with the essential requirements and other relevant provisions of the R&TTE directive 1999/5/EC.
The Declaration of conformity can be found on :

<http://www.topcom.net/support/cedclarations.php>

To be connected to the public analogue telephone network.

The CE symbol indicates that the unit complies with the essential requirements of the R&TTE directive.

The features described in this manual are published with reservation to modifications.

1	Installation	6
1.1	Base	6
1.2	Charger (only in Twin, triple or quattro pack)	6
1.3	Handset	6
2	Keys/LED	7
3	Display (LCD)	8
4	Handset operation	9
4.1	Setting the language	9
4.2	Making PSTN Calls	10
4.3	Receiving a PSTN Call	11
4.4	Activate/deactivate handsfree function	12
4.5	Transferring a call to another handset	12
4.6	Out of Range Warning	12
4.7	Setting the speaker volume	12
4.8	Call Duration Indicator on the display	13
4.9	Turning off the microphone (mute)	13
4.10	Pause key	13
4.11	Conference call (two internal DECT handsets and one external caller)	13
4.12	Locating a misplaced handset (paging)	13
4.13	Using the alphanumeric handset keypad	14
4.14	The Phone Book	14
4.15	Switch the handset ON/OFF	15
4.16	Setting the ring volume level on the handset	16
4.17	Setting the ringer melody on the handset	16
4.18	Setting the ring volume and melody of the base	17
4.19	Locking the key pad	18
4.20	Turning key click ON/OFF	18
4.21	The R key (flash)	18
4.22	Changing the PIN code	19
4.23	Subscribing a handset to a B24xx, 28xx, 29xx, 32xx, 40xx, 46xx	19
4.24	Subscribing Butler 4012 handset on another base (other brand/model)	20
4.25	Removing subscription of a handset to a base unit	21
4.26	Selecting a base unit	21
4.27	Barring outgoing calls	22
4.28	Direct Call	23
4.29	Default settings (reset) of the parameters	23
4.30	Complete reinitialisation of the telephone	24
4.31	Setting the handset dialling mode	24
5	Caller ID/CLIP	24
5.1	Setting the date and time	25
5.2	The Call List	25
5.3	Calling a number from the Call List	26
5.4	Storing a number from the Call List in the Phone Book	26
5.5	Deleting numbers from the Call List	26
6	Voice mail indicator	27

7	USB PC interface operation	27
7.1	Installing the software	27
7.2	General PC call settings	28
7.3	Skype interface	29
7.4	SJ-Phone/Net2Phone interface	33
7.5	MSN Messenger interface	34
8	Trouble shooting	35
9	Technical characteristics	36
10	Topcom warranty	36
10.1	Warranty period	36
10.2	Warranty handling	36
10.3	Warranty exclusions	37

Safety Instructions

- Only use the charger plug supplied. Do not use other chargers, as this may damage the battery cells.
- Only insert rechargeable batteries of the same type. Never use ordinary, non-rechargeable batteries. Insert rechargeable batteries so they connect to the right poles (indicated in the battery compartment of the handset).
- Do not touch the charger and plug contacts with sharp or metal objects.
- The operation of some medical devices may be affected.
- The handset may cause an unpleasant buzzing sound in hearing aids.
- Do not place the basic unit in a damp room or at a distance of less than 1.5 m away from a water source. Keep water away from the handset.
- Do not use the telephone in environments where there is a risk of explosions.
- Dispose of the batteries and maintain the telephone in an environment-friendly manner.
- As this telephone cannot be used in case of a power cut, you should use a mains-independent telephone for emergency calls, e.g. a mobile phone.
- This telephone uses rechargeable batteries. You have to dispose of the batteries in an environment friendly manner according to your country regulations.

Disposal of the device (environment)

At the end of the product lifecycle, you should not throw this product into the normal household garbage but bring the product to a collection point for the recycling of electrical and electronic equipments. The symbol on the product, user guide and/or box indicate this.

Some of the product materials can be re-used if you bring them to a recycling point. By re-using some parts or raw materials from used products you make an important contribution to the protection of the environment.

Please contact your local authorities in case you need more information on the collection points in your area.



Cleaning

Clean the telephone with a slightly damp cloth or with an anti-static cloth. Never use cleaning agents or abrasive solvents.

1 Installation

Before you use the telephone for the first time, you must first make sure the battery is charged for 20 hours. If you do not do this, the telephone will not work optimally.

1.1 Base

For installation, do the following:

- Plug one end of the adaptor into the outlet and the other end into the adapter jack on the bottom of the telephone.
- Connect one end of the telephone cord with the wall phone jack and the other end to the bottom of the telephone.

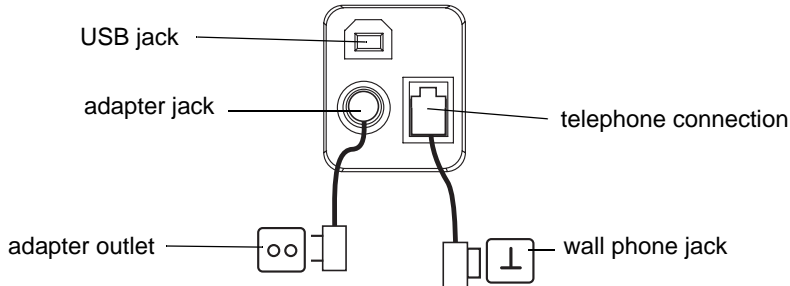

- Connect one end of the USB cable into the USB port of your PC and the other end in the telephone. For the software installation, please go to “USB PC interface operation” on page 27

1.2 Charger (only in Twin, Triple or Quattro pack)



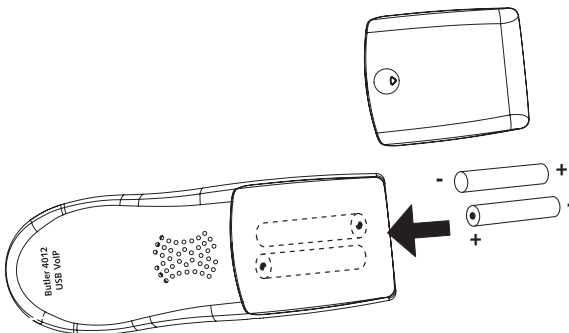

- Connect the AC adaptor to the electric socket

1.3 Handset

- Open the battery compartment (see below).
- Insert the batteries **respecting the (+ and -) polarity**.
- Close the battery compartment.
- Leave the handset on the base unit for 20 hours. The Line/Charge indicator  (LED) on the base unit will light up.



Battery indicator:

-  The battery is fully charged.
-  The battery is half drained (50%)
-  The battery is low. When the battery is low, you will hear warning signals and the battery symbol  on the display will blink.

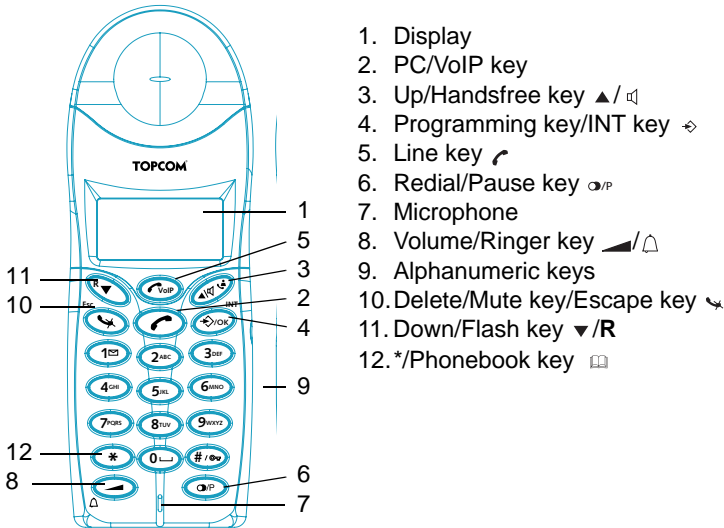
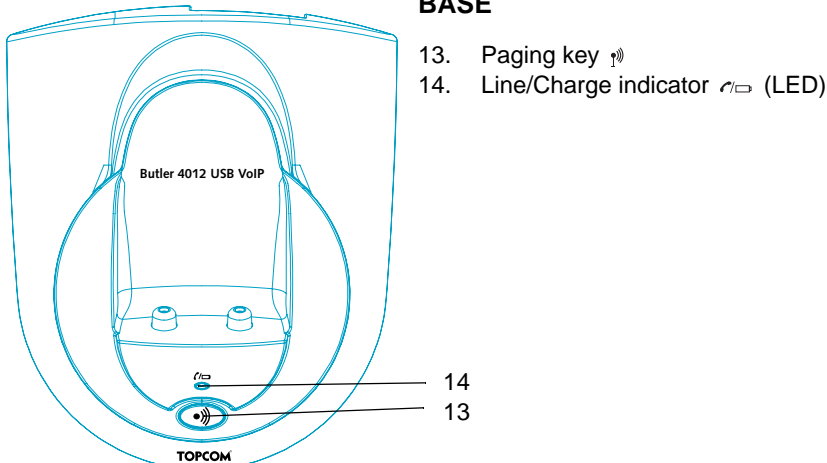
2 Keys/LED**HANDSET****BASE**

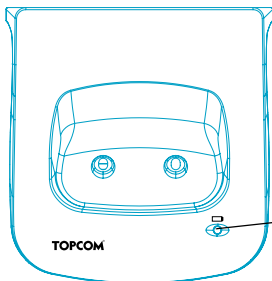





CHARGER

15. Charge indicator 

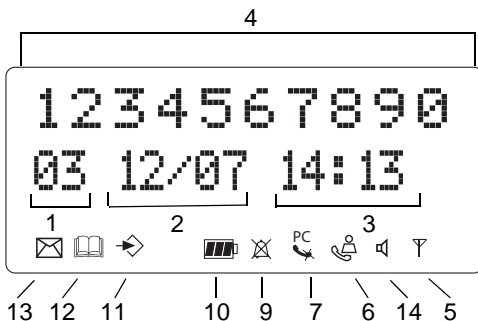
15

3 Display (LCD)



1. Number of calls received.
2. Date (day/month) of calls received.
3. Time (hour:minutes) of calls received.
4. Call information.
5. Symbol display (ψ):
 - this symbol means that the handset is located within the range of the base unit.
 - when this symbol starts blinking, this means you are beyond the range of the base unit. Move closer to the base unit so that the connection between the base unit and the handset can be restored.
6. Symbol display ():
 - this symbol means that the telephone has received calls that are automatically stored in the Call List.
7. Symbol display ():
 - this symbol means that the mute function is activated, the microphone is turned off during a conversation.
8. Symbol display ():
 - this symbol appears on the display when you make or receive a call.
9. Symbol display ():
 - this symbol means that the ringer is turned off. When you receive a call, the telephone does not ring. The telephone will ring when you receive an internal call.

10. Symbol display (🔋):
 - this symbol is the battery indicator.
11. Symbol display (☞):
 - this symbol means you are in the menu.
12. Symbol display (📖):
 - this symbol appears when you browse the numbers in the Phone Book.
13. Symbol display (✉):
 - this symbol appears when you have received a voice mail message (See “6 Voice mail indicator” on page 27).
14. Symbol display (📞):
 - this symbol means that the handsfree function is activated. You can now talk without having to pick up the handset.
 - Blinks when base telephone is active. You can't take the line with the handset as long as base telephone is active!
15. Symbol display (PC):
 - Blinks during incoming PC call
 - Steady during PC calls

4 Handset operation



This section only describes PSTN operation and discards any co-related pc call operations! For PC operation, See "7 USB PC interface operation".

4.1 Setting the language

The telephone has 14 display languages: see display languages table on packaging!!

To set the language, do the following:

- Press the Programming key ☞.
- Press the Up or Down key ▲ ▼ repeatedly until 'SETTING' appears on the display
- Press the Programming key ☞.
- Press the Up or Down key ▲ ▼ repeatedly until 'LANGUAGE' appears on the display.
- Press the Programming key ☞.
- The language set appears on the display.
- Press the Up or Down key ▲ ▼ repeatedly to select the language you would like to use.
- Once the desired language appears on the display, press the Programming key ☞ to confirm your selection or repeatedly press the ESC key to leave the menu.

4.2 Making PSTN Calls



When making external calls through the handset, base telephone operation is not possible!

4.2.1 External Call

- Press the Line key .
- The Line/Charge indicator (LED) on the base unit will blink. 'EXT' and the Call symbol appear on the display.
- You will hear the dial tone. Dial the telephone number you wish to call.
- The number appears on the display and is dialled.
- After finishing your call, press the Line key to hang up.

4.2.2 Number preparation

- Dial the telephone number you wish to call. You can correct the number by pressing the Delete/Mute key .
- Press the Line key .
- The Line/Charge indicator (LED) on the base unit will blink. 'EXT' and the Call symbol appear on the display.
- The telephone number is dialled automatically.
- After finishing your call, press the Line key to hang up.

4.2.3 Redialling the last number dialled

- Press the Line key .
- The Line/Charge indicator (LED) on the base unit will blink. 'EXT' and the Call symbol appear on the display.
- You will hear the dial tone.
- Press the Redial key . The number you last called is dialled automatically.



4.2.4 Redial one of the last 5 numbers dialled

- Press the Redial key .
- Select 'REDIAL' and press OK
- The number you last called appears on the display. If you would like to dial one of the last 5 numbers dialled, press the Redial key a few times until the desired number appears on the display.
- Press the Line key .
- The number shown on the display is dialled automatically.
- After finishing your call, press the Line key to hang up.

4.2.5 Calling a programmed number from the Phone Book



The telephone has a Phone Book in which you can program the telephone number with name. If you would like to call a number from the Phone Book:

- Press the Phone Book key . The first number of the Phone Book appears on the display.
- Press the Up or Down key repeatedly to select the telephone number you wish to call.

- Press the Line key .
- The number shown on the display, is dialled automatically.
- After finishing your call, press the Line key  to hang up.





4.2.6 An internal call: calling another handset

This function only works if multiple handsets are subscribed to the base unit !

- Press the INT key  twice.
- 'INT' appears on the display
- Dial the number of the handset you would like to call.
- After finishing your call, press the Line key  to hang up.





4.3 Receiving a PSTN Call

4.3.1 Receiving an external call

- All subscribed handsets will ring when you receive a call.
- The Call symbol  blinks on the display.
- The telephone number of the caller appears on the display if you have Caller ID service (CLIP). Consult your telephone company. The name of the caller also appears on the display if:
 - the name is programmed into the Phone Book
 - the network sends the name together with the telephone number (FSK CID system only).
- Press the Line key  to accept the external call.
- During the call 'EXT' and the symbol  appear on the display. The call timer starts running.
- After finishing your call, press the Line key  to hang up or put the handset back on the base unit.



4.3.2 Receiving an internal call

This function only works if multiple handsets are subscribed to the base unit!

- The handset rings.
- 'INT' and the number of the handset calling, appear on the display. The Call symbol  blinks on the display.
- Press the Line key  to accept the internal call.
- During the call, 'INT', the handset number of the caller and the symbol  appear on the display. The call timer starts running.
- After finishing your call, press the Line key  to hang up.

4.3.3 Receiving an external call during an internal call

If you receive an external call during an internal call, you will hear a call waiting tone (double beep) on both handsets being used for an internal call.

- Press the Line key  twice to accept the external call.
- After finishing your call, press the Line key  to hang up.

4.4 Activate/deactivate handsfree function

This function allows you to communicate without having to pick up the handset. When you are talking, press the Up/Handsfree key ▲/☐ to activate the handsfree function. Press the same button to deactivate the handsfree function.



When you are calling in handsfree mode and you want to change the volume, press the Volume ▼ button.



When you use the handsfree function for a long time, the batteries will be empty quickly!

4.5 Transferring a call to another handset

- You have an external caller on the line.
- Press the INT key ⇨ twice.
- The external call is now on hold.
- 'INT' appears on the display.
- Dial the number of the handset to which you would like to transfer the call.
- If the handset dialled is answered, you can have an internal conversation. Press the Line key ↶ and the external call is transferred.
- If the handset dialled is not answered, press the Down key ▼ to speak to the external caller again.

4.6 Out of Range Warning

If the handset is out of range of the base unit, a warning signal will sound.

- 'SEARCHING' appears on the display and the symbol γ blinks on the display.
- Move closer to the base unit.
- As soon as you are back within range of the base unit, a signal sounds and the symbol γ stops blinking.

4.7 Setting the speaker volume

Use the Volume/Ringer key ▼/△ to set the volume of the speaker (handset). You can select from 5 levels. The telephone is set to level '3' by default.

During a call, you can change the volume:

- Press the Volume/Ringer key ▼/△.
- The volume level currently set appears on the display.
- Use the number keys to set the desired level (1-5).
- Press the Volume/Ringer key ▼/△ to confirm your selection.



You have 8 seconds to set the desired volume; if you do not, the telephone returns to standby mode and the volume remains unchanged.



The Speaker volume for normal calls and PC-calls are independent.

4.8 Call Duration Indicator on the display







As soon as you press the Line key  the call duration appears on the display (minutes-seconds).

E.g. " 01:20 " for 1 minute and 20 seconds.

The call duration remains visible on the display for 5 seconds after each call.

4.9 Turning off the microphone (mute)

It is possible to turn off the microphone during a call by pressing the Delete/Mute key . Now you can speak freely without the caller being able to hear you.

- You are on the phone. The Line/Charge indicator  (LED) on the base unit will blink and the Call symbol  appears on the display.
- Press the Delete/Mute key  to turn off the microphone.
- The symbol 'X' appears on the display ().
- When you want to resume the conversation, press the Delete/Mute key  again.
- The symbol 'X' disappears from the display (). The person on the other end of the line can hear you again.

4.10 Pause key

If you dial a telephone number and you would like to add a pause to this number, press the Pause key  at the desired place in the number.

When you call this number, this pause (3 seconds) is automatically included.

4.11 Conference call (two internal DECT handsets and one external caller)

You can have a telephone conversation with one internal and one external caller at the same time.

- While on the line with an external caller, press the INT key  twice.
- The external call is now on hold.
- 'INT' appears on the display.
- Dial the number of the handset you would like to include in the call.
- Once the handset dialled is answered, keep the '#' key pressed for 3 seconds.
- 'CONFERENCE' appears on the display.
- Now you are connected to one external and one internal caller (conference call).



4.12 Locating a misplaced handset (paging)

If you cannot find the handset, briefly press the Paging key  on the base unit.

All handsets subscribed with the base unit will sound a signal so you can locate the misplaced handset. To stop the signal, briefly press the Line key  on any handset.

4.13 Using the alphanumeric handset keypad









Use the alphanumeric keypad to type text. To select a letter, press the corresponding key. E.g. if you press the alphanumeric key '5', the first character (j) appears on the display. Press it repeatedly to select other characters from this key.

Press the '2' key twice to select the letter 'B'. If you would like to select both 'A' and 'B' after each other, first press the '2' key once to select 'A', wait 2 seconds until the cursor moves to the next position and then press the '2' key twice to select 'B'. You can delete characters mistakenly typed by using the Delete key . The character in front of the cursor will be deleted. You can move the cursor by pressing the Up and Down keys  .









4.14 The Phone Book

The phonebook allows you to memorise 50 telephone numbers and names. You can enter names of up to 10 characters length and numbers of up to 25 digits length.

4.14.1 Adding a number and a name to the Phone Book

- Press the Programming key .
- Press the Up or Down key   repeatedly until 'PHONE BOOK' appears on the display.
- Press the Programming key .
- 'SEARCH' appears on the display.
- Press the Up or Down key   repeatedly until 'ADD NEW' appears on the display.
- Press the Programming key .
- 'NAME' appears on the display.
- Enter the name. Use the alphanumeric keys.
- Press the Programming key .
- Enter the telephone number. Use the alphanumeric keys.
- Press the Programming key .
- You will hear a long beep. The name and the number are stored in the Phone Book.

4.14.2 Looking up a number in the Phone Book

- Press the Programming key .
- Press the Up or Down key   repeatedly until 'PHONE BOOK' appears on the display.
- Press the Programming key .
- 'SEARCH' appears on the display.
- Press the Programming key .
- Enter the first letters of the desired name.
- Press the Programming key .
- The first name, corresponding with these letters appears on the display.
- Press the Up or Down key   to browse for other numbers in the Phone Book.
- Once the desired number appears on the display, the number will be automatically dialled once the Line key  is pressed.



You can also enter the phonebook by press and hold the phonebook key  for 3 seconds!

4.14.3 Changing a name or number in the Phone Book

- Press the Programming key ⇨.
- Press the Up or Down key ▲ ▼ repeatedly until 'PHONE BOOK' appears on the display.
- Press the Programming key ⇨.
- 'SEARCH' appears on the display.
- Press the Up or Down key ▲ ▼ repeatedly until 'EDIT' appears on the display.
- Press the Programming key ⇨.
- The first number in the Phone Book appears on the display.
- Press the Up or Down key ▲ ▼ until the desired number appears on the display.
- Press the Programming key ⇨ to change the selected number programmed into the memory.
- Press the Delete key ✕ to delete each letter of the name and use the alphanumeric keypad to enter the correct name.
- Press the Programming key ⇨.
- Press the Delete key ✕ to delete each digit of the number and use the alphanumeric keypad to enter the correct number.
- Press the Programming key ⇨ to save the changes made.

4.14.4 Deleting name and number from the Phone Book

- Press the Programming key ⇨.
- Press the Up or Down key ▲ ▼ repeatedly until 'PHONE BOOK' appears on the display.
- Press the Programming key ⇨.
- 'SEARCH' appears on the display.
- Press the Up or Down key ▲ ▼ repeatedly until 'DELETE' appears on the display.
- Press the Programming key ⇨.
- The first number in the Phone Book appears on the display.
- Press the Up or Down key ▲ ▼ until the number you want to delete appears on the display.
- Press the Delete key ✕ .
- 'DELETE ?' appears on the display.
- Press the Programming key ⇨ to confirm that you want to delete it.

4.15 Switch the handset ON/OFF

4.15.1 Switch the handset off

The handset is turned on.

- Press the Programming key ⇨.
- Press the Up or Down key ▲ ▼ repeatedly until 'POWER OFF?' appears on the display.
- Press the Programming key ⇨. The telephone turns itself off. You cannot dial any more numbers, nor receive any calls.



If you would like to leave the menu without turning off the handset, press the Delete/Mute key ✕.

4.15.2 Switch the handset on

The handset is turned off.

- Press the Programming key ⇨. The telephone turns itself on.

4.16 Setting the ring volume level on the handset

You can change the ring volume of an incoming call. You have 10 levels. You can set the ring volume of internal and external calls separately so you can hear a difference.

If you select level '0', the symbol ☒ appears on the display and you no longer hear the phone ring when an external call is received (you still hear it ring for internal calls).

Level '9' is the highest level. The telephone is set to level '5' by default.

4.16.1 Setting the ring volume for external calls (0-9)

- Press the Programming key ⇨.
- Press the Up or Down key ▲ ▼ repeatedly until 'RING SEL' appears on the display.
- Press the Programming key ⇨.
- 'EXTERNAL' appears on the display.
- Press the Programming key ⇨.
- Press the Up or Down key ▲ ▼ repeatedly until 'VOLUME' appears on the display.
- Press the Programming key ⇨.
- The current volume level used appears on the display.
- Enter a number between 0 and 9 to select the desired ringer volume. Use the number keypad to do this.
- Press the Programming key ⇨ to confirm your selection.

4.16.2 Setting the ringer volume for internal calls (1-9)

- Press the Programming key ⇨.
- Press the Up or Down key ▲ ▼ repeatedly until 'RING SEL' appears on the display.
- Press the Programming key ⇨.
- 'EXTERNAL' appears on the display.
- Press the Up or Down key ▲ ▼ repeatedly until 'INTERNAL' appears on the display.
- Press the Programming key ⇨.
- Press the Up or Down key ▲ ▼ repeatedly until 'VOLUME' appears on the display.
- Press the Programming key ⇨.
- The current volume level appears on the display.
- Enter a number between 1 and 9 to select the desired ringer volume. Use the number keypad to do this.
- Press the Programming key ⇨ to confirm your selection.

4.17 Setting the ringer melody on the handset

You can change the ringer melody for an incoming call. You have 18 ringer melodies to choose from (1-18).

4.17.1 Setting a ringer melody for external calls (1-18)

- Press the Programming key ⇨.
- Press the Up or Down key ▲ ▼ repeatedly until 'RING SEL' appears on the display.
- Press the Programming key ⇨.

- 'EXTERNAL' appears on the display.
- Press the Programming key ↵.
- 'MELODIES' appears on the display.
- Press the Programming key ↵.
- The currently set ringer melody appears on the display.
- Enter a number between 1 and 9 to select the desired ringer melody. Use the number keypad to do this.
- Press the Programming key ↵ to confirm your selection.

4.17.2 Setting a ringer melody for internal calls (1-9)

- Press the Programming key ↵.
- Press the Up or Down key ▲ ▼ repeatedly until 'RING SEL' appears on the display.
- Press the Programming key ↵.
- 'EXTERNAL' appears on the display.
- Press the Up or Down key ▲ ▼ repeatedly until 'INTERNAL' appears on the display.
- Press the Programming key ↵.
- 'MELODIES' appears on the display.
- Press the Programming key ↵.
- The currently set ringer melody appears on the display.
- Enter a number between 1 and 9 to select the desired ringer melody. Use the number keypad for this.
- Press the Programming key ↵ to confirm your selection.

4.18 Setting the ring volume and melody of the base

4.18.1 Setting the base ring volume (0-9)

- Press the Programming key ↵.
- Press the Up or Down key ▲ ▼ repeatedly until 'RING SEL' appears on the display.
- Press the Programming key ↵.
- 'EXTERNAL' appears on the display.
- Press the Up or Down key ▲ ▼ repeatedly until 'BASE' appears on the display.
- Press the Programming key ↵.
- Press the Up or Down key ▲ ▼ repeatedly until 'VOLUME' appears on the display.
- Press the Programming key ↵.
- The current volume level used appears on the display.
- Enter a number between 0 and 9 to select the desired ringer volume. Use the number keypad to do this.
- Press the Programming key ↵ to confirm your selection.

4.18.2 Setting a ringer melody

- Press the Programming key ↵.
- Press the Up or Down key ▲ ▼ repeatedly until 'RING SEL' appears on the display.
- Press the Programming key ↵.
- 'EXTERNAL' appears on the display.
- Press the Up or Down key ▲ ▼ repeatedly until 'BASE' appears on the display.
- Press the Programming key ↵.

- Press the Up or Down key ▲ ▼ repeatedly until 'VOLUME' appears on the display.
- Press the Programming key ⇨ .
- The current volume level used appears on the display.
- Enter a number between 0 and 9 to select the desired ringer volume. Use the number keypad to do this.
- Press the Programming key ⇨ to confirm your selection.

4.19 Locking the key pad

If you lock the alphanumeric keypad, it is impossible to dial a telephone number. Only the Programming key ⇨ can still be used. 'KEY LOCKED' will be displayed on the display.

- Press the Programming key ⇨.
- Press the Up or Down key ▲ ▼ repeatedly until 'KEY SETUP' appears on the display.
- Press the Programming key ⇨.
- 'KEY LOCK' appears on the display.
- Press the Programming key ⇨.
- The current status of the keypad appears on the display:
 - 'LOCK': the keypad is locked
 - 'UNLOCK': the keypad is not locked
- Press the Up or Down key ▲ ▼ to make your selection.
- Press the Programming key ⇨ to confirm your selection.



You can also Press and hold the #-key until KEY LOCK appear. To unlock, press and hold the #-key again.

4.20 Turning key click ON/OFF

You can set the telephone to make a sound whenever you press a key.

- Press the Programming key ⇨.
- Press the Up or Down key ▲ ▼ repeatedly until 'KEY SETUP' appears on the display.
- Press the Programming key ⇨.
- Press the Up or Down key ▲ ▼ repeatedly until 'KEY CLICK' appears on the display.
- Press the Programming key ⇨.
- The current status appears on the display:
 - 'CLICK ON': turn on key click
 - 'CLICK OFF': turn off key click
- Press the Up or Down key ▲ ▼ to make your selection.
- Press the Programming key ⇨ to confirm your selection.

4.21 The R key (flash)

Press the Flash key 'R' to use certain services such as "call waiting" (if your telephone company offers this feature); or to transfer calls if you use a telephone exchange (PABX). The Flash key 'R' is a brief interruption of the line. You can set the flash time to 100ms or

300ms. This is set to 100ms by default! However, if your system requires a longer flash time, do the following:

- Press the Programming key ↻.
- Press the Up or Down key ▲ ▼ repeatedly until 'SETTING' appears on the display
- Press the Programming key ↻.
- Press the Up or Down key ▲ ▼ repeatedly until 'RECALL' appears on the display.
- Press the Programming key ↻.
- Press the Up or Down key ▲ ▼ repeatedly to select the flash time:
 - SHORT = 100ms
 - LONG = 300ms
- Press the Programming key ↻ to confirm your selection.

4.22 Changing the PIN code

Certain functions are only available if you know the PIN code of the telephone. The PIN code has 4 digits. The default PIN code setting is '0000'. If you would like to change the default PIN code and set your own secret code, do the following:

- Press the Programming key ↻.
- Press the Up or Down key ▲ ▼ repeatedly until 'SETTING' appears on the display.
- Press the Programming key ↻.
- Press the Up or Down key ▲ ▼ repeatedly until 'PIN CODE' appears on the display.
- Press the Programming key ↻.
- 'OLD CODE' appears on the display.
- Enter the old PIN code. Use the number keys.
- Press the Programming key ↻.
- 'NEW CODE' appears on the display.
- Enter the new PIN code in. Use the number keys.
- Press the Programming key ↻.
- 'AGAIN' appears on the display.
- Enter the new PIN code again. Use the number keys.
- Press the Programming key ↻.
- You hear a confirmation tone. The new PIN code has been set.



Do not forget your personal PIN code. If you do, you have to restore the default settings (reset – See “4.30 Complete reinitialisation of the telephone” on page 24).

4.23 Subscribing a handset to a B24xx, 28xx, 29xx, 32xx, 40xx, 46xx

In order to be able to make and receive telephone calls, a new handset has to be subscribed to the base unit. You can subscribe 5 handsets to one base unit. By default, each handset is subscribed as handset 1 on the base unit upon delivery (base unit 1).

!!! You only need to subscribe the handset if:

- the handset subscription has been removed from the base unit (e.g. for reinitialisation)
- you want to subscribe a different handset to this base unit.

The underlined procedure is only applicable to a B40XX handset and base unit!!!

Keep the Paging key » on the base unit pressed for 10 seconds until The Line/Charge indicator 𐀀 on the base unit begins to blink rapidly. The Line/Charge indicator 𐀀 will blink rapidly for one minute. During this minute, the base unit is in subscribing mode and you must do the following to subscribe the handset:

- Press the Programming key ⇨.
- Press the Up or Down key ▲ ▼ repeatedly until 'BASE SUB' appears on the display.
- Press the Programming key ⇨.
- 'BASE _ ' appears on the display.
- Enter a number of the base unit you would like to subscribe the handset to (1-4). Use the number keypad.
- 'SEARCHING' and the symbol γ appears on the display.



Each handset can be subscribed to 4 different DECT base units. Each base unit is assigned a number from 1 to 4 in the handset. When you subscribe a new handset, you can assign a base unit number. It is best to use '1'.

- The RFPI code (each base unit has a unique RFPI code) appears on the display and a signal sounds when the handset has found the base unit.
- Press the Programming key ⇨.
- 'PIN' appears on the display.
- Enter the 4-digit PIN code of the base unit in (default PIN code is '0000'). Use the number keypad.
- Press the Programming key ⇨.
- The handset is subscribed to the base unit.

4.24 Subscribing Butler 4012 handset on another base (other brand/model)

Put the base in subscription mode (see manual of the base). If the base is in subscribing mode, you have to do the following to subscribe the handset:

- Press the Programming key ⇨.
- Press the Up or Down key ▲ ▼ repeatedly until 'BASE SUB' appears on the display.
- Press the Programming key ⇨.
- 'BASE _ ' appears on the display.
- Enter a number for the base unit to which you would like to subscribe the handset (1-4).
- Use the number keypad.
- 'SEARCHING' and the symbol γ appear on the display.
- The RFPI code (each base unit has a unique RFPI code) appears on the display and a signal sounds once the base unit is found by the handset.
- Press the Programming key ⇨.
- 'PIN' appears on the display.
- Enter the 4-digit PIN code of the base unit (default PIN code is '0000'). Use the number keypad.
- Press the Programming key ⇨.
- The handset is subscribed to the base unit.

4.25 Removing subscription of a handset to a base unit

It is possible to cancel subscription of a handset to a base unit. You would do this if a handset is damaged and has to be replaced by a new one.



You can only cancel subscription of another handset, not the handset you are using to do the cancellation procedure.

- Press the Programming key ⇨.
- Press the Up or Down key ▲ ▼ repeatedly until 'SETTING' appears on the display.
- Press the Programming key ⇨.
- Press the Up or Down key ▲ ▼ repeatedly until 'REMOVE HS' appears on the display.
- Press the Programming key ⇨.
- 'PIN' appears on the display.
- Enter your 4-digit PIN code in (default PIN code is '0000'). Use the number keypad.
- Press the Programming key ⇨.
- 'REMOVE HS' appears on the display.
- Dial the number of the handset you want to remove (1 –5). Use the number keypad.
- Press the Programming key ⇨.
- 'REMOVE HS' appears on the display and the handset is removed
- 'NOT SUB' appears on the handset removed.

4.26 Selecting a base unit

If your handset is subscribed to several base unit stations (max. 4) , you must select a base unit because the handset can only communicate with one base unit at a time. There are two possibilities:

4.26.1 Automatic selection

If you set the handset to 'automatic selection', the handset will automatically choose the closest base unit in standby.

- Press the Programming key ⇨.
- Press the Up or Down key ▲ ▼ repeatedly until 'SETTING' appears on the display.
- Press the Programming key ⇨.
- Press the Up or Down key ▲ ▼ repeatedly until 'BASE SEL' appears on the display.
- Press the Programming key ⇨.
- Press the Up or Down key ▲ ▼ repeatedly until 'AUTO' appears on the display.
- Press the Programming key ⇨.
- 'SEARCHING' and the symbol γ appear on the display.
- A signal sounds once the handset has found a base unit.

4.26.2 Manual selection

If you set the handset to 'manual selection', the handset will only choose the base unit you have set.

- Press the Programming key ⇨.
- Press the Up or Down key ▲ ▼ repeatedly until 'SETTING' appears on the display.
- Press the Programming key ⇨.
- Press the Up or Down key ▲ ▼ repeatedly until 'BASE SEL' appears on the display.
- Press the Programming key ⇨.
- Press the Up or Down key ▲ ▼ repeatedly until 'MANUAL' appears on the display.
- Press the Programming key ⇨.
- 'BASE -' appears on the display.
- Enter the number of the base unit you want to select (1-4). Use the number keypad.
- Press the Programming key ⇨.
- 'SEARCHING' and the symbol γ appear on the display.
- A signal sounds once the selected base unit has been found.



- **Before you can select a base unit, the base unit must be subscribed to the handset first.**
- **If 'NOT SUB' appears on the display, this means the selected base unit does not exist or the handset has not been subscribed.**

4.27 Barring outgoing calls

You can program the handsets to bar calls to certain telephone numbers so that for instance '00' international numbers cannot be called. Up to 5 numbers (of max. 5 digits) can be barred. To do this, do the following:

- Press the Programming key ⇨.
- Press the Up or Down key ▲ ▼ repeatedly until 'SETTING' appears on the display.
- Press the Programming key ⇨.
- Press the Up or Down key ▲ ▼ repeatedly until 'BARRING' appears on the display.
- Press the Programming key ⇨.
- 'PIN' appears on the display.
- Enter your PIN code
- Press the Programming key ⇨.
- 'BAR NUM' appears on the display. You are in memory "1. _ _ _ _ _".
- Press the Up or Down key ▲ ▼ to select one of the 5 memories.
- Enter the number (max. 5 digits) to be barred, e.g. 01486.
- Press the Programming key ⇨.
- 'HS _ _ _ _ _' (= number on the handset (1-5)) '01486' (= the barred numbers) appear on the display.
- Enter the numbers of the handsets from which the barred numbers cannot be called.
- e.g. Press the number key 2, 3 and 5. On the display, this will appear: HS _2_3_5_01486
These handsets can no longer dial numbers beginning with '01486'.
- Press the Programming key ⇨ to confirm your selection. Repeat the same procedure described above if you would like to bar other numbers (max. 5)!

4.28 Direct Call

By setting a Direct Call number, the phone will automatically take the line and dial out this number. This function is useful to use the phone as a emergency phone.

4.28.1 To program the Direct Call number

- Press the Programming key ⇨
- Press the Up or Down key ▲ ▼ until 'DIRECT' appears on the display
- Press the Programming key ⇨
- If necessary, delete the existing number by pressing the Delete-key a few times
- Enter the direct number
- Press the Programming key ⇨

4.28.2 Turn the Direct Call function ON/OFF

To turn it ON:

- Press the Programming key ⇨
- Press the Up or Down key ▲ ▼ until 'DIRECT' appears on the display
- Press the mute-key ✎ for 2s
- 'DIRECT ON' appears on the display

To turn if OFF:

- Quick press the Programming key ⇨ twice

4.29 Default settings (reset) of the parameters

You can reset the standard (default) settings in the telephone. You need the PIN code to do this.

The default settings are:

Keypad:	not locked
Key clicks:	active
Speaker volume:	level
Ringer melody:	1
Ringer volume :	5
Selection base unit:	automatic
Flash time:	100ms

To restore the default settings, do the following:

- Press the Programming key ⇨.
- Press the Up or Down key ▲ ▼ repeatedly until 'SETTING' appears on the display.
- Press the Programming key ⇨.
- Press the Up or Down key ▲ ▼ repeatedly until 'RESET' appears on the display.
- Press the Programming key ⇨.
- 'PIN' appears on the display.
- Enter your PIN code.
- Press the Programming key ⇨.

4.30 Complete reinitialisation of the telephone

This function allows you to completely reinitialise the telephone without requiring your PIN code. This will delete all Phone Book memory entries, all handsets will be removed, all default settings will be restored and the default PIN code will be restored to '0000'.

Do the following:

- Disconnect the battery in the telephone.
- Keep the '*' key pressed and reconnect the battery until the handset rings continually and the display lights up. Release the '*' button and press the Programming key ↵.
- The handset finds the base unit and a signal sounds.
- Briefly press the '*' key.
- 'RESET ?' appears on the display.
- Press the Programming key ↵ to confirm your selection of disconnect the battery to discontinue the procedure.
- 'RESETTING' appears on the display and a long beep tone sounds.
- 'NOT SUB' appears on the display. The handset is completely reinitialised.

Afterwards, you must resubscribe all handsets as described in point 4.23! However you no longer need to set the base unit to subscription mode, because this now happens automatically!

4.31 Setting the handset dialling mode

There are two types of dialling modes:

- DTMF/Tone dialling (the most common)
- Pulse dialling (for older installations)

To change the mode of numeration:

- Press the Programming key ↵
- Press the Up or Down key ▲ ▼ repeatedly until 'SETTING' appears on the display.
- Press the Programming key ↵
- Press the Up or Down key ▲ ▼ repeatedly until 'DIAL MODE' appears on the display.
- Press the Programming key ↵
- Select 'TONE' or 'PULSE' by means of the UP and Down key ▲ ▼
- Press the Programming key ↵ to confirm

5 Caller ID/CLIP

(This service only works when you have a Caller ID/Clip subscription. Contact your telephone company).

When you receive a call, the telephone number of the caller, the date and time appears on the handset display. The telephone can receive calls in both FSK and DTMF. If the name is programmed in the Phone Book, the name in the Phone Book is displayed!

The telephone can store 30 calls in a Call List that can be reviewed later. The telephone never stores the same call twice. When the memory is full, the new calls automatically

replace the oldest calls in the memory. The symbol  on the display blinks if the call is not read or not answered. If the Call List is empty and you press the Up key ▲, three beep tones will sound.

You can view the information of an incoming call as follows:

- Press the Up key ▲, select 'CLIP' and press OK
- Press the Up key ▲. The name (if sent by the network or present in the Phone Book memory) of the caller, the sequence number of the call in the Call List, the date and time of the call appear on the display.
- Press the Down key ▼. The telephone number of the caller appears on the display.

5.1 Setting the date and time

When you receive an incoming call and the date and time are not sent together with the telephone number or PC TIME (see "PC TIME Settings" on page 29) is not On, this means that the date and the time will not be shown on the display. By setting the date and time, they will be shown on the display, together with the telephone number, every time a call comes in !

- Press the Programming key ⇨.
- Press the Up or Down key ▲▼ a few times until 'SETTING' appears on the display.
- Press the Programming key ⇨.
- 'DATE/TIME' appears on the display.
- Press the Programming key ⇨ again.
- When 'YEAR' appears on the display, enter the 2 last numbers of the year (00=2000, 01=2001, ...) and press the Programming key ⇨ to confirm.
- When 'MONTH' appears on the display, enter the month (01=January, 02=February, ...) and press the Programming key ⇨ to confirm.
- When 'DAY' appears on the display, enter the day of the month and press the Programming key ⇨ to confirm.
- When 'HOUR' appears on the display, enter the current hour (in 24h format) and press the Programming key ⇨ to confirm.
- When 'MINUTES' appears on the display, enter the minutes and press the Programming key ⇨ to confirm.

The date and time are now set !

5.2 The Call List

The calls received are stored in the Call List (max. 30 numbers).

- Briefly press the Up key ▲ to view the most recent call.
- Select 'CLIP' and press OK
- The name of the most recent caller appears on the display. If no name is available, 'NO NAME' appears on the display.
- If it is a private number, 'UNAVAIL' appears on the display.
- The date and time the call was received are linked to each call.
- Briefly press the Down key ▼ to view the telephone number of the call.
- Briefly press the Down key ▼ to browse other numbers on the list.



- If neither the Up or Down key ▲ ▼ is pressed for 15 seconds, the telephone will return to standby mode.
- After a call is received, the number of the caller remains on the display for 15 seconds after the last ring.
- Caller ID is not available while you are on the line.

5.3 Calling a number from the Call List

- Press the Up key ▲, select 'CLIP' and press OK
- Press the Up key ▲ to look up the desired call. Press the Down key ▼ to view the telephone number.
- Once the number is on the display, press the Line key ↷ and the number is dialed automatically. (The symbols ☎ and 'EXT' appear on the display and the call timer starts.)

5.4 Storing a number from the Call List in the Phone Book

- Press the Up key ▲, select 'CLIP' and press OK
- Press the Up key ▲ to look up the desired number.
- Press the Phone Book key ☎ twice.
- 'STORE' appears on the display.
- The number is stored in the Phone Book. If the call was displayed without a name (NO NAME), you can add a name to this number in the Phone Book afterwards
- The telephone returns to standby-modus.

5.5 Deleting numbers from the Call List

5.5.1 Deleting one number



- Press the Up key ▲, select 'CLIP' and press OK
- Press the Up key ▲ to find the call you would like to delete.
- Once this call appears on the display, press the Delete key ✖ .
- 'DELETE?' appears on the display.
- Press the Programming key ⇨ to confirm your selection or the Delete key ✖ to cancel.
- The call is deleted and the next call appears on the display.

5.5.2 Delete all numbers

- Press the Up key ▲, select 'CLIP' and press OK
- Keep the Delete key ✖ pressed until 'DELETE ALL' appears on the display.
- Press the Programming key ⇨ to confirm your selection or the Delete key ✖ to cancel.
- All calls are deleted.

6 Voice mail indicator

This function only works if you have the voice mail or phone mail service and if the network sends this indication along with the caller ID (CLIP) information!

When you receive a new message in your voice mail system, the  icon will appear on the display. Once you have listened to your messages, the  icon will disappear.

7 USB PC interface operation



This section only describe the phone functions when making calls over internet (VoIP) !

7.1 Installing the software

You can only make or receive calls over internet when you have a internet connection and one of the following programs installed:

- Skype: downloadable from <http://www.skype.net/go/getskype>
- MSN Messenger
- SJ-Phone or Net2Phone

Minimum system requirements:

- PC Running under Windows XP or 2000
 - 32 MB free memory
 - 20 MB Free hard disk space
 - Internet connection with 56Kbps or higher
- Install the software from the CD included with the phone:



**For the latest version of the software please look at our website:
<http://www.topcom.net/support/downloads.php>**

- Insert the CD when the PC is on. If the program doesn't run automatically, click on the Start icon and select Run. Enter D:\CD_Start.exe (if D in not your CD-ROM drive, enter the appropriate letter)
- The installation wizard will guide you through the process
- Reboot the PC after installation

- Plug the USB plug of the phone to the PC after your PC has been started up again.

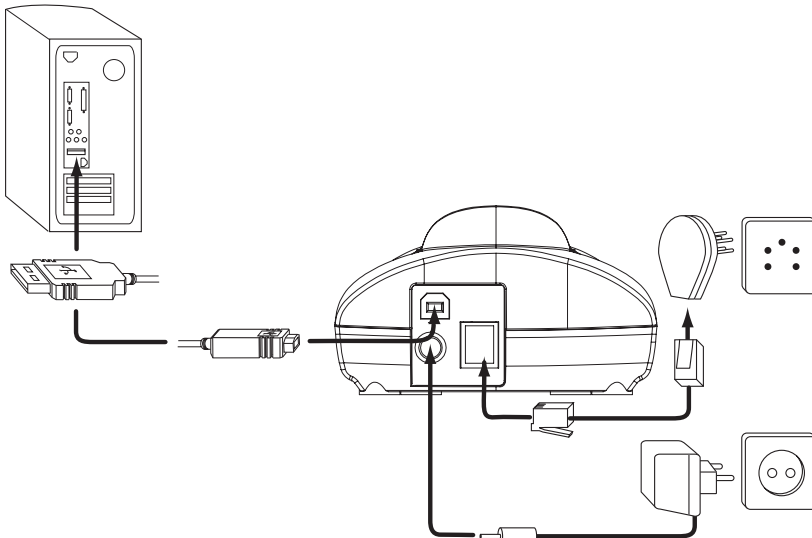

- Windows will install the proper USB driver for the phone
- Select the appropriate interface for Skype, MSN Messenger, SJ-phone or Net2Phone at the Butler 4012 software program
- Open the corresponding internet phone program

7.2 General PC call settings

7.2.1 Setting the PC ringer melody and volume on the handset

You can change the ringer volume and melody for an incoming PC call. You have 18 ringer melodies and 9 volumes to choose from.

- Press the Programming key ↻.
- Press the Up or Down key ▲ ▼ repeatedly until 'RING SEL' appears on the display.
- Press the Programming key ↻.
- 'PC RING' appears on the display.
- Press the Programming key ↻.
- Press the Up or Down key ▲ ▼ repeatedly to select the volume or ring melody setting
- Press the Programming key ↻.
- The currently set ringer melody or volume appears on the display.
- Enter a number between 0 and 9 to select the desired ringer volume or 1-18 for the melody. Use the number keypad to do this.
- Press the Programming key ↻ to confirm your selection.

7.2.2 PC TIME Settings

When the PC time setting is On the Call log will use the PC clock to store the date and time of incoming calls:

- Press the Programming key ↻.
- Press the Up or Down key ▲ ▼ repeatedly until 'SETTINGS' appears on the display.
- Press the OK.
- Press the Up or Down key ▲ ▼ repeatedly until PC TIME appears on the display
- Press OK and select ON or OFF
- Press OK to confirm

7.3 Skype interface



This section describes the operation under Skype! For more information on Skype: www.skype.com

MAKE SURE YOU HAVE SELECTED 'SKYPE' as interface in the Butler 4012 program:

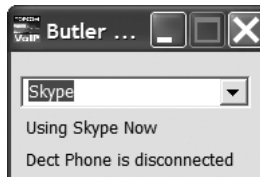

7.3.1 General comments:

- In idle mode the display of the phone will show you the net status (online, off line, etc...)
- 'NO CONNECT' will be displayed when the USB connection fails or when the Butler 4012 software isn't installed or open.

7.3.2 Making Skype calls

Receiving an incoming Skype calls

When you receive an incoming Skype call, the callers nickname will be shown on the handset display

Press the  VoIP-key to answer the call



Press the  VoIP-key to end the call



When you have a Skype subscription, the calling number if available will be shown during a Skypeln call.

Making a Skype call from the online buddy list:

The buddy list is your personal Skype contact list.

- Press the  VoIP-key
- The Skype nickname is show on the display.
- Press the Up or Down key ▲ ▼ repeatedly to scroll through the on-line buddy list.
- Press the OK-key to toggle between the Skype nickname and account ID name.
- Press the  VoIP-key to start making the call
- Press the  VoIP-key again to end the call



If the Skype nickname contains special characters the phone can't display, the account ID name will be shown instead.

Making a Skype call using speed-dial numbers

!! Make sure you have add speed dial numbers to your contacts/buddies



- Enter the speed-dial number (0-99)
- Press the  VoIP-key to start making the call







You can also store speed dial numbers into the phonebook (See "4.14 The Phone Book").

Making a SkypeOUT call

To make skype out calls you have to buy Skypeout credits!!

- Enter the telephone number
- Press the  VoIP-key
- Press the  VoIP-key again to end the call

Redial one of the last 5 numbers dialled

- Press the Redial key .
- Select 'PC OUT' by the Up ▲ or Down key ▼ and press OK
- The number/skype nick name you last called appears on the display.
- Press the Redial key  a few times until the desired number appears on the display.
- Press the OK-key to toggle between the Skype nickname and account ID name.
- Press the Up ▲ key to see the date and time
- Press the  VoIP-key to make the call
- The number shown on the display is dialled automatically.
- After finishing your call, press the VoIP key  to hang up.

7.3.3 Interworking Skype calls and normal PSTN calls



This section describe the interworking between normal PSTN calls and Skype calls.







When you receive two calls at the same time (PSTN and PC call) the first call will be showed on the display. You can answer one of both calls by pressing the corresponding off-hook key.

During a conversation an incoming second call :



1) During normal PSTN conversation and incoming Skype call, the calling Skype nick name will be showed on the display and an alert beep will be heard. The PC icon will blink on the display:

- Press the line key  to end the normal call and to answer the PC call:
The Handset will start to ring
Press the  VoIP-key to answer the PC call





OR

- Press OK key to enter the menu.
- Press the Up or Down key   repeatedly until 'SWITCH' appears on the display and press OK. The line will be switched to PC call and the PSTN call will be put on hold.
- To switch back to PSTN call, press OK key again -> select SWITCH and press OK
- To end both calls press the line  or  VoIP-key

2) During Skype conversation and incoming PSTN call, the calling number (or name) will be shown on the display if callerID is available.





- Press the  VoIP-key to end the Skype call and to answer the PSTN call:
The Handset will start to ring
Press the line -key to answer the PSTN call

OR

- Press OK key to enter the menu.
- Press the Up or Down key   repeatedly until 'SWITCH' appears on the display and press OK. The line will be switched to PSTN call and the PC call will be put on hold.
- To switch back to PC call, press OK key again -> select SWITCH and press OK
- To end both calls press the line  or  VoIP-key

7.3.4 The PC Call List

The calls received are stored in the skype program. The PC call list contains the missed calls and received calls.

- Briefly press the Up key . Select 'PC-IN' by the Up  or Down key  and press OK.
- The nickname of the most recent caller appears on the display.
- Press the Up-key  to show the net status and date/time
- The date and time the call was received are linked to each call.
- Briefly press the Down key  to browse other numbers on the list.



- If neither the Up or Down key ▲ ▼ is pressed for 15 seconds, the telephone will return to standby mode.
- After a call is received, the number of the caller remains on the display for 15 seconds after the last ring.
- Caller ID is not available while you are on the line.

Calling a number from the Call List

- Briefly press the Up key ▲. Select 'PC-IN' and press OK.
- Press the Down key ▼ to look up the desired call.
- Once the number is on the display, press the  VoIP-key to make the call. (The symbols ☎ and 'EXT' appear on the display and the call timer starts.)

7.3.5 Setting the Net status via handset

- Press the Programming key ⇨.
- Press the Up or Down key ▲ ▼ repeatedly until 'NET STATUS' appears on the display.
- Press the OK.
- Press the Up or Down key ▲ ▼ repeatedly to select the desired Net status
- Press OK to confirm.
- The currently Net status will appear on the display in standby



When setting the net status to 'offline' or 'do not disturb', the handset will not ring during incoming Skype call.

7.3.6 Skype Voicemail access





To have voicemail you need to have voicemail subscription.

When you have voicemail subscription and you have received a new message, the  -icon appears on the display.

You can also send a voicemail message to one of your skype buddies by the menu (outbox) without calling them first.

Listen to your voicemail messages

- Press the Programming key ⇨.
- Press the Up or Down key ▲ ▼ repeatedly until 'VOICE MAIL' appears on the display.
- Press the OK.
- Press the Up or Down key ▲ ▼ repeatedly and select 'INBOX'
- Press OK to confirm and to enter the list of messages.
- Press ▲ to scroll through the list, or press ▼ to see the netstatus and date/time of the message. New unread messages are shown with the  -icon.
- Press the  VoIP-key to listen to the message



You can also enter the voicemail menu directly by pressing and holding the '1' or -key.

Send a voicemail message directly

- Press the Programming key .
- Press the Up or Down key repeatedly until 'VOICE MAIL' appears on the display.
- Press the OK.
- Press the Up or Down key repeatedly and select 'OUTBOX'
- Press OK to confirm and to enter the list of all buddies
- Press the Up or Down key repeatedly to scroll to the buddy you want to send a voice message
- Press the VoIP-key to start the recording
- To end the recording, press the VoIP-key again. To voicemail message will be send.

7.4 SJ-Phone/Net2Phone interface



This section describes the operation under SJ-Phone/Net2Phone!

MAKE SURE YOU HAVE SELECTED 'SJ-Phone' or 'Net2Phone' in the Butler 4012 program:



7.4.1 Incoming call

- When you receive an incoming call the 'EXT' will blink together with the 'PC' logo to indicate it's a PC call.
- Press the VoIP-key to answer the call
- To end the call press the line or VoIP-key

7.4.2 Making a PC call

- Enter the telephone number you want to dial
- Press the VoIP-key to dial out the number
- To end the call press the line or VoIP-key

7.5 MSN Messenger interface



This section describes the operation under MSN Messenger !





MAKE SURE YOU HAVE SELECTED 'MSN Messenger' in the Butler 4012 program:







The interworking between MSN messenger and the telephone only works if MSN messenger is opened and minimized in the application tray:



7.5.1 Incoming call

- When you receive an incoming only the PC screen will show that someone is calling
- Press the  VoIP-key to enter the contact list
- Press the Up or Down key ▲ ▼ repeatedly to scroll to the calling person and press the  VoIP-key
- To end the call press the line  or  VoIP-key

7.5.2 Making a PC call

- Press the  VoIP-key to enter the contact list
- Press the Up or Down key ▲ ▼ repeatedly to scroll to contact person you want to call and press the  VoIP-key
- To end the call press the line  or  VoIP-key

8 Trouble shooting

Symptom	Possible cause	Solution
No display	Batteries uncharged	Check the position of the batteries Recharge the batteries
	Handset turned OFF	Turn ON the handset
No tone	Telephone cord badly connected	Check the telephone cord connection
	The line is occupied by another handset	Wait until the other handset hangs up
The icon Ψ flashes	Handset out of range	Bring the handset closer to the base
	The base has no power supply	Check the mains connection to the base
	The handset is not registered to the base	Register the handset to the base
Base or handset do not ring	The ringing volume is zero or low	Adjust the ringing volume
Tone is good, but there is no communication	The dialling mode is wrong	Adjust the dialling mode (pulse/tone)
Telephone does not react to pressing the keys	Manipulation error	Remove the batteries and but them back in place
	Keypad lock ON	Turn OFF the Keypad Lock
Flash (R) Key does not work	Wrong Flash time	Change the flash time
No audio for PC calls in the DECT phone	The audio device for Speech is not set correct in Windows to 'USB phone' or 'C-media USB headset'	Go to 'Control panel', and select 'Audio and sound devices' -> select 'Speech' -> make sure both playback and voice recording are set to 'C-media USB headset'
	The Skype application doesn't use the telephone as audio device	Open Skype and select 'Tools' -> 'Options'. At the 'Privacy' settings, select 'manage other programs access skype' and make sure only Butler 4012 is shown in the list

	The skype audio devices are not set to the USB phone	Open Skype and select 'Tools' -> 'Options'. At the 'Sound devices' settings, make sure all are set to the 'C-media USB headset'
No PC sound anymore when using other applications	The audio device for Audio is not set correct in Windows to you PC audio card	Go to 'Control panel', and select 'Audio and sound devices' -> select 'Audio' -> make sure both playback and recording are set to your PC audio card

9 Technical characteristics

Standard: **DECT** (**D**igital **E**nhanced **C**ordless **T**elecommunications)
GAP (**G**eneric **A**ccess **P**rofile)

Frequency range: 1880 MHZ to 1900 MHZ
Number of channels: 120 duplex channels
Modulation: GFSK
Speech coding: 32 kbit/s
Emission power: 10 mW (average power per channel)
Range: 300 m in open space /50 m maximum inhouse
Base power supply: 230 V / 50 Hz for the base
Handset Batteries: 2 rechargeable batteries AAA, NiMh 600mAh
Handset autonomy: 120 hours in standby
Talk time: 13 hours
Charging time: 6-8 hours
Normal conditions of use: +5 °C to +45 °C
Dialling mode: Pulse / Tone

10 Topcom warranty

10.1 Warranty period

The Topcom units have a 24-month warranty period. The warranty period starts on the day the new unit is purchased. The warranty on batteries is limited to 6 months after purchase. Consumables or defects causing a negligible effect on operation or value of the equipment are not covered.

The warranty has to be proven by presentation of the original purchase receipt, on which the date of purchase and the unit-model are indicated.

10.2 Warranty handling

A faulty unit needs to be returned to a Topcom service centre including a valid purchase note.

If the unit develops a fault during the warranty period, Topcom or its officially appointed service centre will repair any defects caused by material or manufacturing faults free of charge.

Topcom will at its discretion fulfil its warranty obligations by either repairing or exchanging the faulty units or parts of the faulty units. In case of replacement, colour and model can be different from the original purchased unit.

The initial purchase date shall determine the start of the warranty period. The warranty period is not extended if the unit is exchanged or repaired by Topcom or its appointed service centres.

10.3 Warranty exclusions

Damage or defects caused by incorrect treatment or operation and damage resulting from use of non-original parts or accessories not recommended by Topcom are not covered by the warranty.

Topcom cordless phones are designed to work with rechargeable batteries only. The damage caused by the use of non-rechargeable batteries is not covered under warranty.

The warranty does not cover damage caused by outside factors, such as lightning, water and fire, nor any damage caused during transportation.

No warranty can be claimed if the serial number on the units has been changed, removed or rendered illegible.

Any warranty claims will be invalid if the unit has been repaired, altered or modified by the buyer or by unqualified, non-officially appointed Topcom service centres.

TOPCOM[®]

visit our website
www.topcom.net

U8006500/UK